

GMC/CHEVROLET

SAVANA/EXPRESS



UPFIT GUIDE

RANGERTM
DESIGN

Helping Mobile Technicians Work More Effectively by Providing Organized Storage Solutions

At Ranger Design, we believe more is possible.

We believe work vehicles and the technicians that drive them can become more organized, more efficient, more productive and more profitable. At Ranger Design we're committed to bringing you the products and services that make that possible.

More means helping you choose the right work van for your

application, as well as giving you engineering support and expert advice to help design the most efficient work space in your new vehicle.

More also means getting that new van outfitted and on the road faster, so you can start using it for the reason you bought it.

We're committed to bringing you more, because we believe more is possible.



MORE IS POSSIBLE



TABLE OF CONTENTS

CHOOSE A PRODUCT LINE	P. 4
PLAN YOUR VAN OUTFIT	P. 6
GETTING STARTED	P. 8
FLOORS	P. 10
PARTITIONS	P. 12
PACKAGES	P. 14
SHELVING	P. 34
DRAWERS	P. 43
ACCESSORIES	P. 52
LADDER RACKS	P. 62
HOW TO BUY	P. 64
INDEX	P. 66

Choose A Product Line To Match Your Needs

Ranger Fleetline and Proline product groups ensure that fleets of any size have the best equipment to fit their budget, trade or fuel saving targets.



	MATERIAL	BENEFITS	PRODUCTS	WARRANTY
WHY BUY RANGER FLEETLINE? You want better quality and price than other steel products on the market.	Steel	Tough Low cost Quiet	Shelving, Partitions, Drawers, Accessories	3 years*
WHY BUY RANGER PROLINE? You want the toughest, quietest product on the market. You need to optimize payload without sacrificing quality.	Aluminum	Toughest Lightweight Quiet	Shelving, Partitions, Drawers, Accessories, Ladder Racks	10 years*

*Ranger Design Inc. van equipment is warranted to be free from defects in material and workmanship under normal use and service for the period indicated, from the date of the original retail purchase, when installed per Ranger Design instructions in the original vehicle. Please contact Customer Service for full warranty details. Email: cs@rangerdesign.com

Throughout the catalog **FLEETLINE** products are depicted with yellow and **PROLINE** products with black.

1-800-565-5321
7 A.M. – 8 P.M. EST

World Class Customer Service



Real people, ready to answer in 2 rings or less*

We are pleased to offer efficient, personalized service and to answer all questions regarding:

- › Pricing/Quoting
- › Product install
- › Order status
- › Consultation
- › Shipment status
- › New product availability
- › Product specifications
- › Warranty claims
- › Returns/Restocking
- › Vehicle specifications

*Call customer service and the phone will be answered in 2 rings or less. Yes, a real, live person working in one of our offices in North America is available to answer your questions. No automated attendant. No complicated phone tree and offshore service. Call us to experience the difference.

PLANNING YOUR VAN OUTFIT

INSIDE ROOF HEIGHT

To determine the maximum shelf height that can be used in the van.

PARTITION DEPTH

This indicates the space taken up by our partition for this vehicle. Please note that this measurement is determined by the partition that encroaches the most. Some partitions may take up less space. Take note that this measurement may not necessarily be on the floor.

DOOR OPENING

To determine where shelving will land in relation to the door opening. Use this measurement to determine the space available for drawer units.

DIMENSIONS IN RED

These dimensions indicate unique measurements for each wheelbase. Use red dimensions to determine the exact wheelbase of your van.

FLOOR SPACE

This area is usable floor space but due to curvature of the van there may not be the same available area at the roof. Please measure actual van for specific measurement at roof.

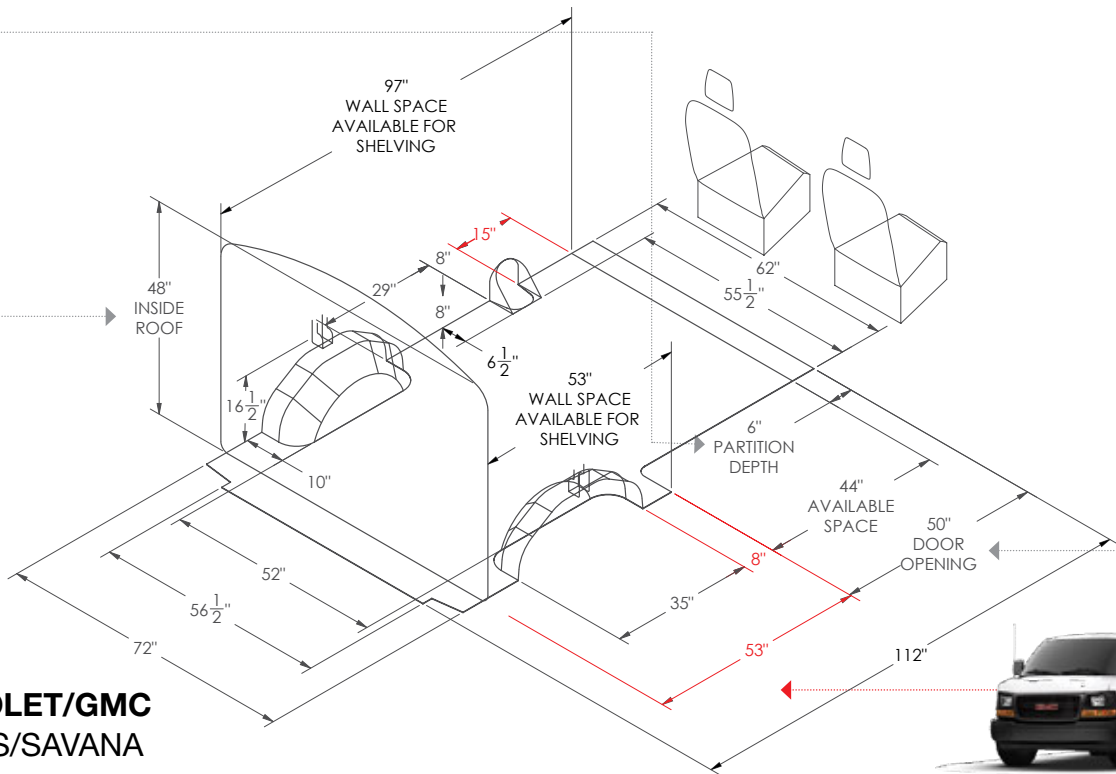

CHEVROLET/GMC EXPRESS/SAVANA

Regular 135" Wheelbase



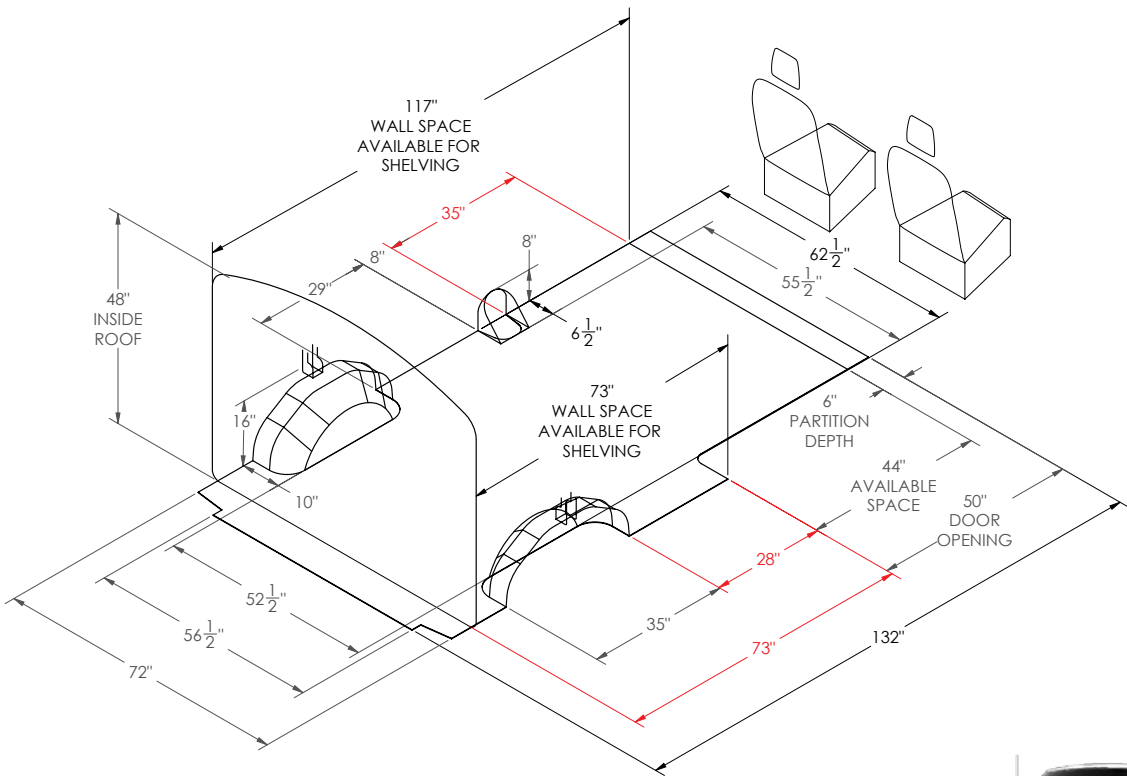

CHEVROLET/GMC EXPRESS/SAVANA

Extended 155" Wheelbase

ADD YOUR **ACCESSORIES**
P.52



PICK YOUR **PARTITION**
P.12

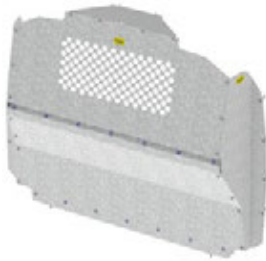

CHOOSE YOUR **LADDER RACK**
P.62



Take a few minutes to write down these simple steps

Plan your storage zones

For how long do you plan to use the vehicle? A year 2–5 years 10 years or more (see page 4)

Will payload capacity be an issue? Yes No Why? _____

What type of industry are you in? _____

What kind of partition do I need?

Do I need to see my cargo or see out the side doors? Yes No

Do I need the ability to go from the cabin to the cargo area through the partition? Yes No

List the equipment/products you will need to store

Place the items that you need most often in the most accessible locations.

	How often will you use this?			Zone
	Daily	Weekly	Monthly	
_____	<input type="checkbox"/>	<input type="checkbox"/>	<input type="checkbox"/>	A-B-C-D-E
_____	<input type="checkbox"/>	<input type="checkbox"/>	<input type="checkbox"/>	_____
_____	<input type="checkbox"/>	<input type="checkbox"/>	<input type="checkbox"/>	_____
_____	<input type="checkbox"/>	<input type="checkbox"/>	<input type="checkbox"/>	_____
_____	<input type="checkbox"/>	<input type="checkbox"/>	<input type="checkbox"/>	_____

Will I need to carry larger objects Yes No

List the tools you will need to carry

Place heavy tools closest to the access doors.

	How often will you use this?			Zone
	Daily	Weekly	Monthly	
_____	<input type="checkbox"/>	<input type="checkbox"/>	<input type="checkbox"/>	A-B-C-D-E
_____	<input type="checkbox"/>	<input type="checkbox"/>	<input type="checkbox"/>	_____
_____	<input type="checkbox"/>	<input type="checkbox"/>	<input type="checkbox"/>	_____
_____	<input type="checkbox"/>	<input type="checkbox"/>	<input type="checkbox"/>	_____
_____	<input type="checkbox"/>	<input type="checkbox"/>	<input type="checkbox"/>	_____

What kind of ladder(s) will I be carrying? Step ladder Extension ladders
 Size _____ Size _____

Storage Zones

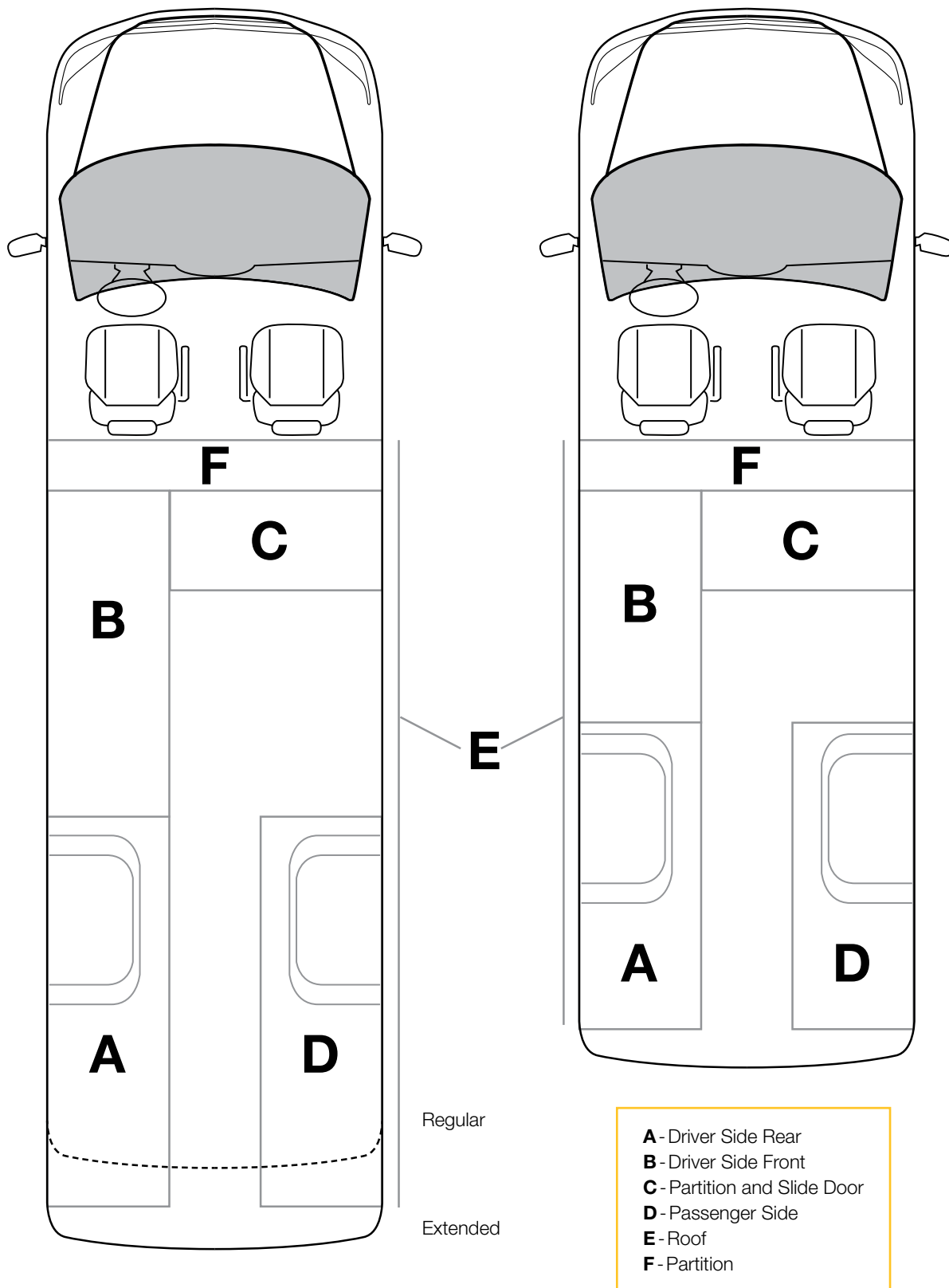

IT'S MORE THAN A FLOOR

Ranger Design's unique flooring system with integrated aluminum mounting tracks provide a flush surface, making it easy to install a variety of Ranger Design shelving, equipment and accessories.

Ranger Designs' custom-fit rigid flooring system is available for every type of service van. Designed to provide added safety and quieter ride, these impact and puncture-resistant floors give your van a professional look.

Unique benefits of these flooring products include:

- › **Economical** – because the flooring has integrated mounting tracks for the price of a regular floor
- › **Safer** – due to the integrated track, improved load distribution and noise reduction
- › **Improved van resale value** – durable professional looking and protects the vehicle
- › **Efficient** – 3 panel floor installed in 45 minutes by one person and easy to maintain



PROTECTION

The floor protects your vehicle and prevents damage to the factory floor.



SAFETY

Due to the integrated track, improved load distribution and noise reduction.



EFFICIENCY

Custom-fit easy to install by one person.

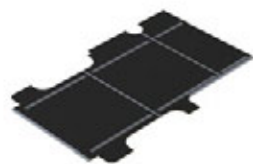

6540-GSR

Savana 135" floor

135"

74 lbs

1 hr

Yes

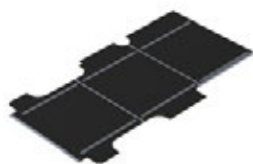

6540-GSX

Savana 155" floor

155"

89 lbs

1 hr

Yes

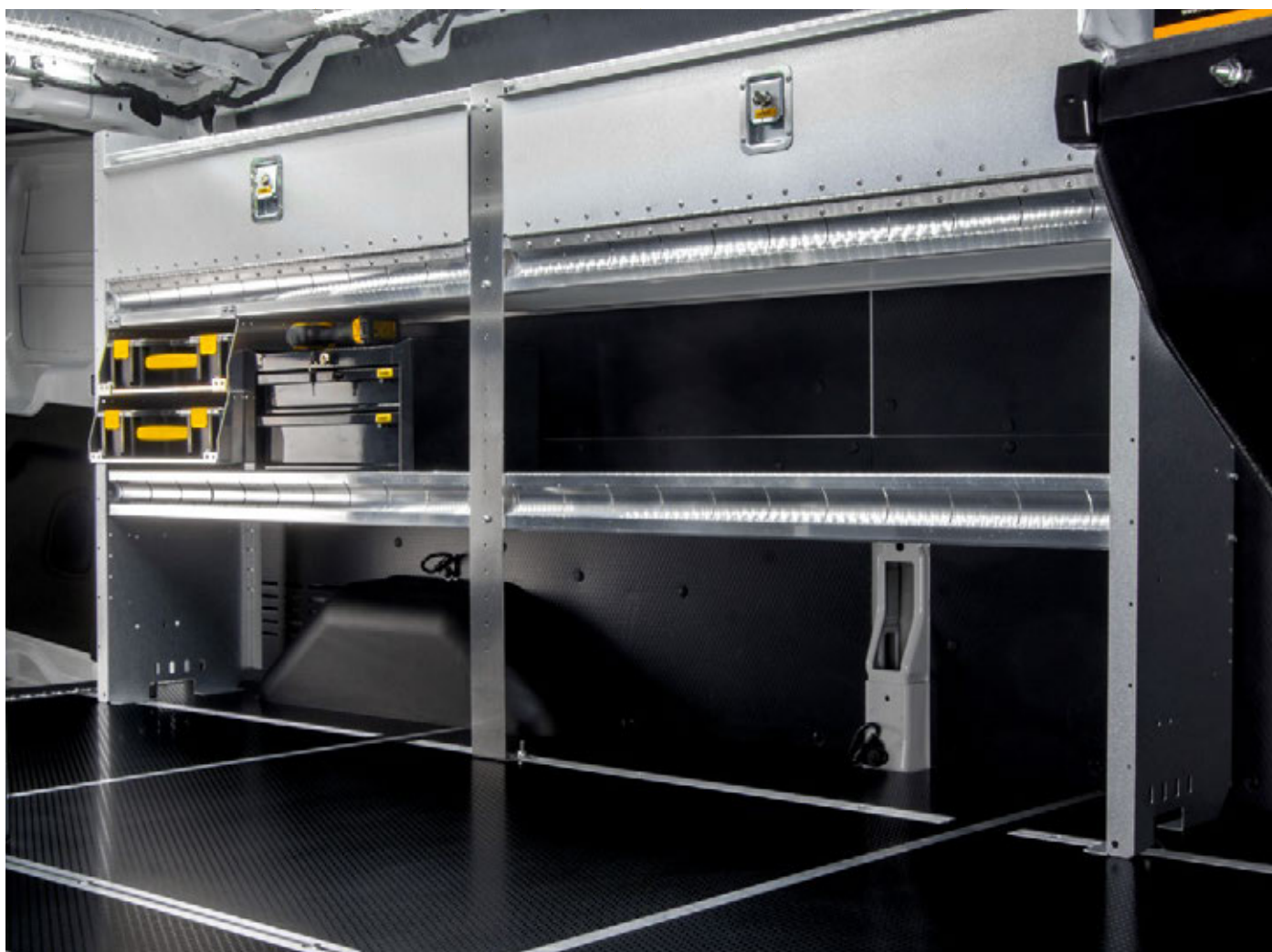

Impact and puncture resistant floors preserve the cargo van interior.

SAFETY PARTITIONS

Impact tested safety partitions protect the most important asset: you

Ranger Design safety partitions provide a solid and secure barrier between the occupants of the van and the cargo.

Built from heavy gauge steel and aluminum, they are designed for maximum impact resistance and uphold a standard of safety set only by Ranger Design products.

Ranger Design partitions also provide a more comfortable environment for the driver by giving more seat travel and by not rattling as the vehicle drives down the road.

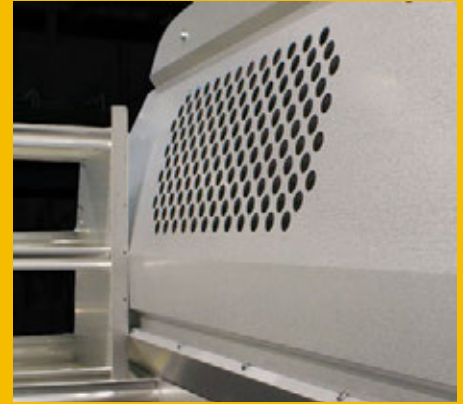

SAFE

Designed for maximum impact resistance. Proven by impact testing.

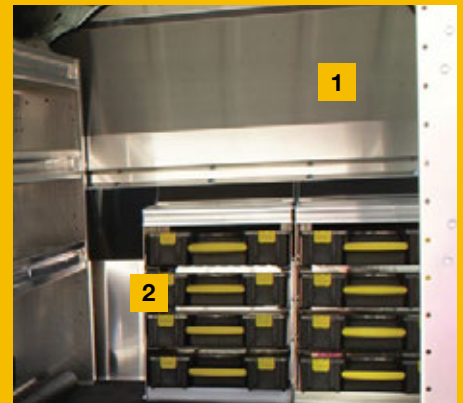

EFFICIENT

1. Contoured to maintain seat travel and ensure driver comfort. 2. Contoured to capitalize on cargo area floor space.



QUIET

Thickness of material cancels vibrations.



CONTOURED SAFETY PARTITIONS

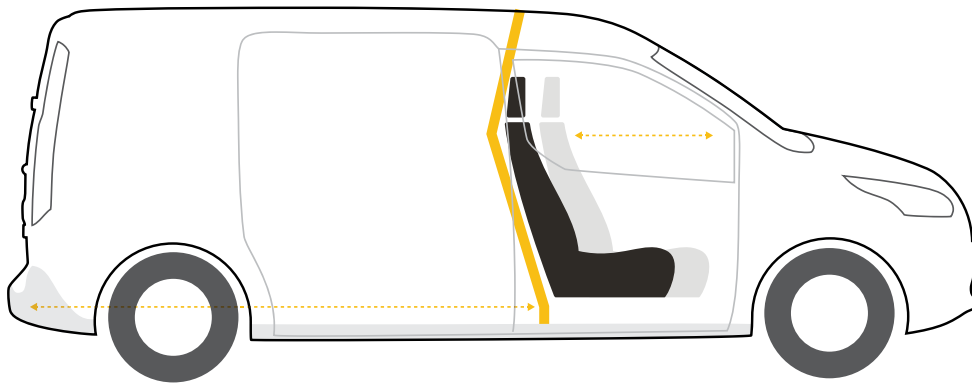

1. Contoured to maintain seat travel and ensure driver comfort.
2. Contoured to capitalize on cargo area floor space.



3010-GS

Contoured Safety Partition

Aluminum

Standard Roof

42 lbs

1 hr

Yes

5.6"



3020-GS

Contoured Safety Partition with Tempered Glass Window

Aluminum

Standard Roof

49 lbs

1 hr

No

5.6"



C10-H

Contoured Safety Partition with Perforated Window

Steel

Standard Roof

53 lbs

1 hr

Yes

5.6"

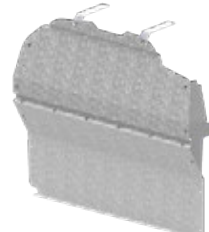

C12-H

Contoured Safety Partition

Steel

Standard Roof

53 lbs

1 hr

No

5.6"



C20-GS

Straight Partition with Perforated Window, No Access

Steel

Standard Roof

61 lbs

1.5 hr

No

6.75"



C24-GS

Straight Walk Through Partition

Steel

Standard Roof

47 lbs

1 hr

No

6.75"



C30-GS

Straight Partition with Perforated Window

Steel

Standard Roof

63 lbs

1 hrs

No

6.75"

SETBACK FROM B PILLAR

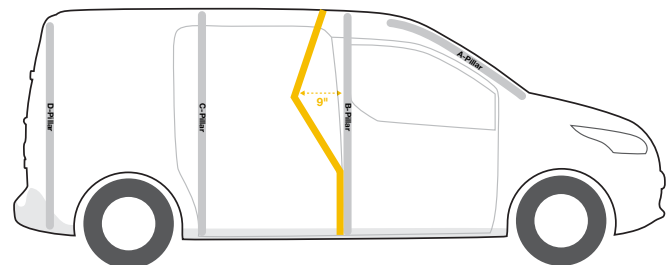



TRADE PACKAGES

Pre-engineered packages
for a broad range of trades.



CHOICE

A range of Fleetline and Proline packages are available for each vehicle.



TRADE SPECIFIC

Packages are created with the specific trades in mind. Optimized for maximum productivity.



PERFECT FIT

Engineered to optimize space. Layout designed to ensure that all tools are well within reach.

TRADE PACKAGES

BOX TRUCK P. 30

CONTRACTOR P. 16

DELIVERY P. 28

ELECTRICAL P. 18

HVAC P. 20

PLUMBER P. 22

SERVICE P. 24

Get more out of your work van: Ranger Design packages are designed specifically with your trade in mind. Our aim is to ensure that your most frequently used tools and equipment are well within reach.

Do you see a way that we can improve our packages? We appreciate your feedback! Contact our customer service team at **1-800-565-5321**.



CONTRACTOR PACKAGES

PACKAGES

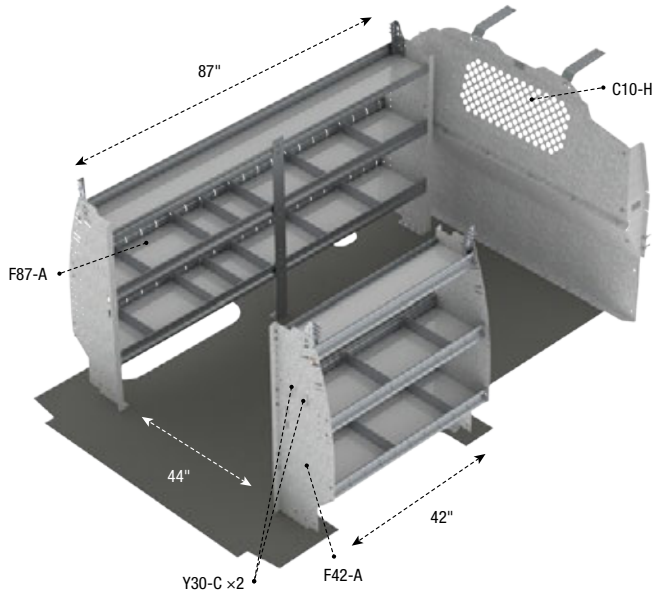

Z05-H Base Contractor Package

Steel

135", 155"	Standard	204 lbs
3.4 hrs	Yes	

Qty	Part #	Description
1	C10-H	Partition, contoured
1	F42-A	Shelf unit, contoured
1	F87-A	Shelf unit, contoured
2	Y30-C	Small hook

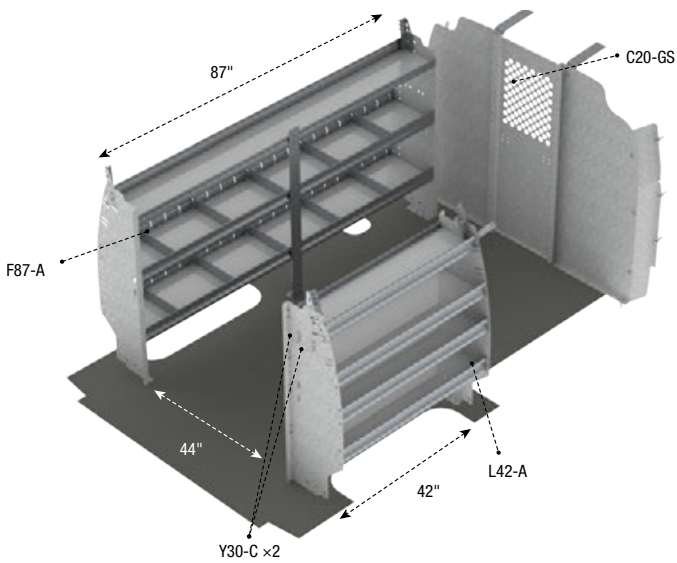

Z10-H Base Contractor Package

Steel

135", 155"	Standard	215 lbs
3.4 hrs	No	

Qty	Part #	Description
1	C20-GS	Partition, straight, full-size van
1	F87-A	Shelf unit, contoured
1	L42-A	Shelf unit, contoured
2	Y30-C	Small hook

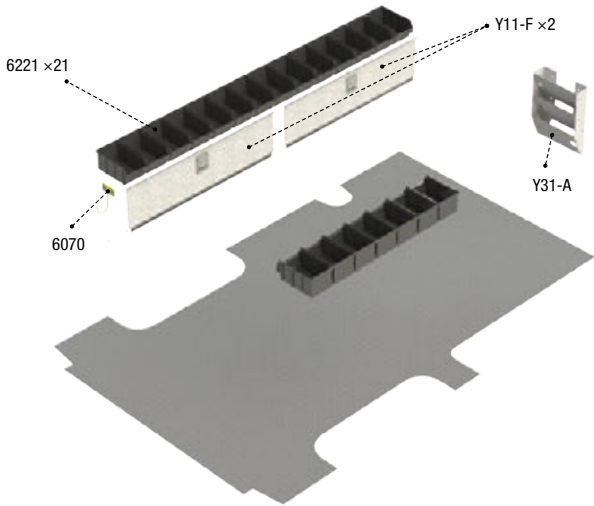

Z30-H Contractor Package

Steel

135", 155"	Standard	47 lbs
1.4 hrs	Yes	

Qty	Part #	Description
1	6070	Large hook, fixed
2	Y11-F	Locking door kit
1	Y31-A	Paper Holder, extra deep, 3 slots
21	6221	Stacking bin, graphite, medium

PACKAGES



You can do more, by choosing the right package that gets you into service fast.



A211

Electrical Package

*Preproduction model shown, do not use as an installation guide.



QUIET

The combination of the extrusion shelf tray and end-panels create durable, vibration-free shelves.



EFFICIENT

Ergonomic design reduces injuries and increases productivity.



TOUGH

Extrusion builds durability into shelf.

ELECTRICAL PACKAGES

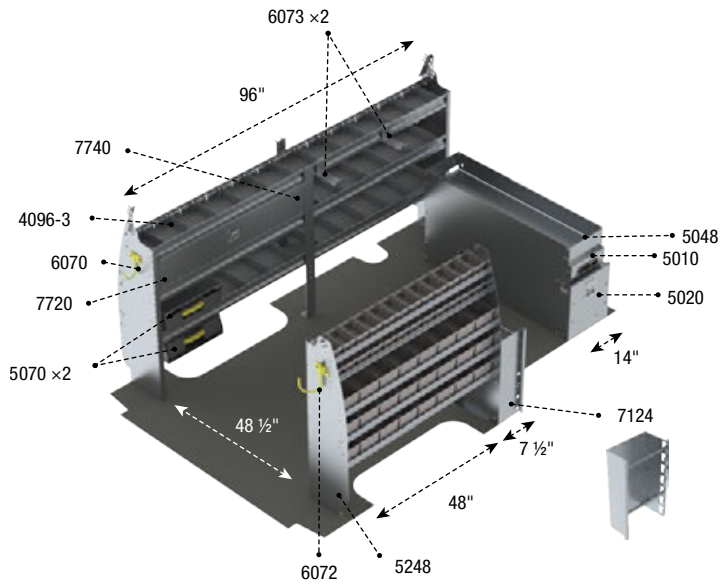

A211 Deluxe Electrical Package

Aluminum

135", 155"	Standard	310 lbs
6.2 hrs	No	

Qty	Part #	Description
1	4096-3	Shelf unit, contoured, full-size van
1	5010	Partslider drawer
1	5020	Tool drawer
1	5048	Partslider drawer, top edge
2	5070	Partskeeper shelf mount
1	5248	Bin unit, contoured, full-size van
1	6070	Large hook, fixed
1	6072	Large hook, swivel
2	6073	Large hook
1	7124	Reel holder
1	7720	Locking door kit
1	7740	Shelf block, universal kit

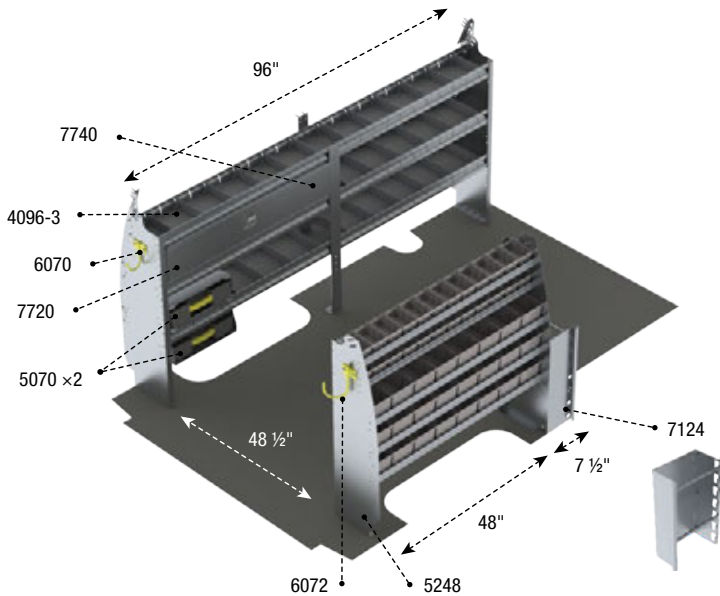

A311 Base Electrical Package

Aluminum

135", 155"	Standard	208 lbs
4.5 hrs	No	

Qty	Part #	Description
1	4096-3	Shelf unit, contoured, full-size van
2	5070	Partskeeper shelf mount
1	5248	Bin unit, contoured, full-size van
1	6070	Large hook, fixed
1	6072	Large hook, swivel
1	7124	Reel holder
1	7720	Locking door kit
1	7740	Shelf block, universal kit

PACKAGES

Choose a layout design that will be the perfect fit for your toughest job.



A212

HVAC Package

*Preproduction model shown, do not use as an installation guide.



QUIET

The combination of the extrusion shelf tray and end-panels create durable, vibration-free shelves.



EFFICIENT

Ergonomic design reduces injuries and increases productivity.



TOUGH

Extrusion builds durability into shelf.

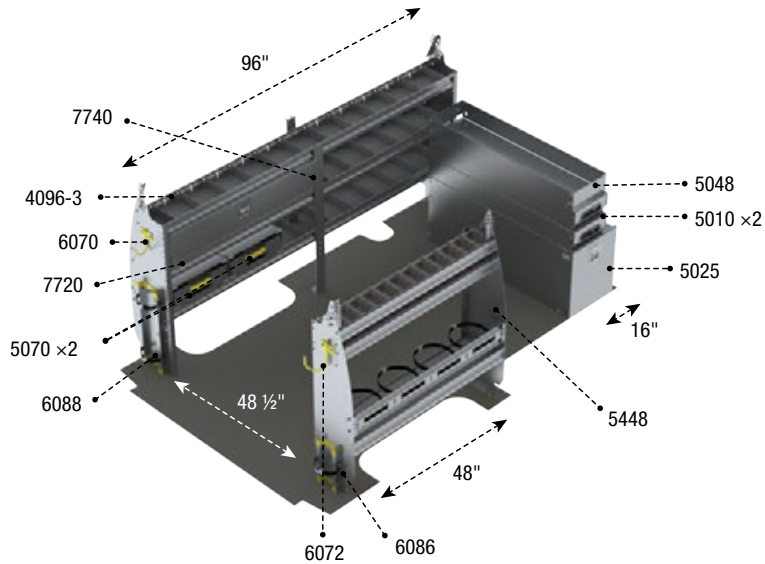

A212

Deluxe HVAC Package

Aluminum

135", 155"	Standard	325 lbs
6.6 hrs	No	

Qty	Part #	Description
1	4096-3	Shelf unit, contoured, full-size van
2	5010	Partslider drawer
1	5025	Tool drawer
1	5048	Partslider drawer, top edge
2	5070	Partskeeper shelf mount
1	5448	Bin unit, contoured, full-size van
1	6070	Large hook, fixed
1	6072	Large hook, swivel
1	6086	Bottle rack
1	6088	Bottle rack
1	7720	Locking door kit
1	7740	Shelf block, universal kit

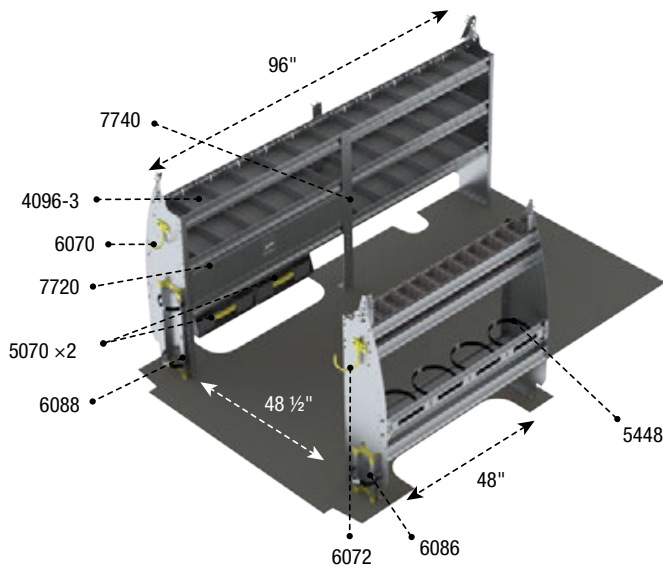

A312

Base HVAC Package

Aluminum

135", 155"	Standard	186 lbs
4.4 hrs	No	

Qty	Part #	Description
1	4096-3	Shelf unit, contoured, full-size van
2	5070	Partskeeper shelf mount
1	5448	Bin unit, contoured, full-size van
1	6070	Large hook, fixed
1	6072	Large hook, swivel
1	6086	Small bottle holder
1	6088	Large bottle holder
1	7720	Locking door kit
1	7740	Shelf block, universal kit



The right Van Accessories that can make a big difference, choose the ones to meet your individual needs.

A215

Plumber Package

*Preproduction model shown, do not use as an installation guide.



QUIET
The combination of the extrusion shelf tray and end-panels create durable, vibration-free shelves.



EFFICIENT
Ergonomic design reduces injuries and increases productivity.



TOUGH
Extrusion builds durability into shelf.

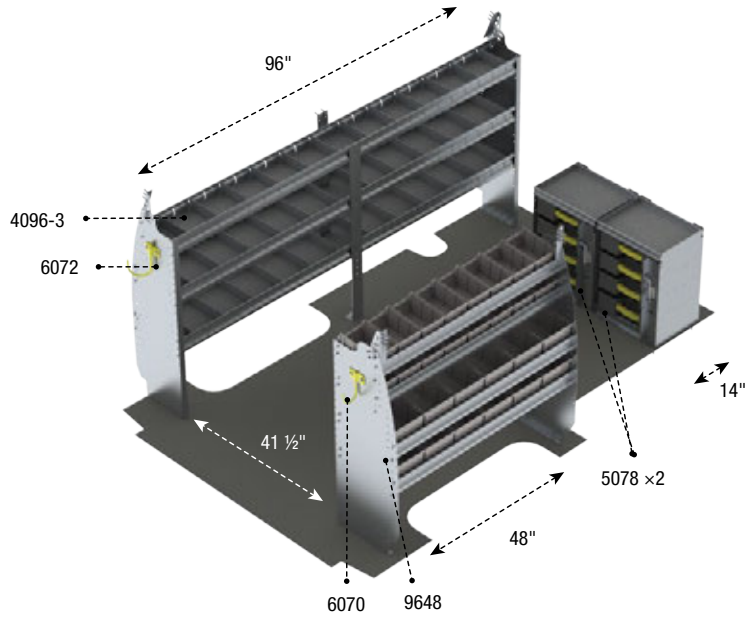

A215

Deluxe Plumber Package

Aluminum

135", 155"	Standard	250 lbs
3 hrs	No	

Qty	Part #	Description
1	4096-3	Shelf unit, contoured, full-size van
2	5078	Partskeeper cabinet - 4 carry cases
1	6070	Large hook, fixed
1	6072	Large hook, swivel
1	9648	Bin unit, contoured, full-size van

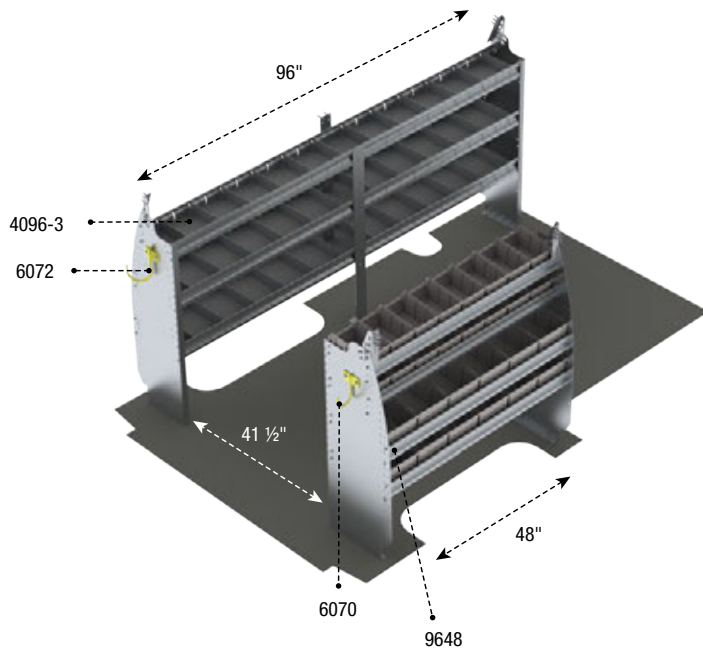

A315

Base Plumber Package

Aluminum

135", 155"	Standard	195 lbs
2.4 hrs	No	

Qty	Part #	Description
1	4096-3	Shelf unit, contoured, full-size van
1	6070	Large hook, fixed
1	6072	Large hook, swivel
1	9648	Bin unit, contoured, full-size van

Efficient layout helps you save money, prevent injury and increase payload.



A216

Service Package

*Preproduction model shown, do not use as an installation guide.



QUIET

The combination of the extrusion shelf tray and end-panels create durable, vibration-free shelves.



EFFICIENT

Ergonomic design reduces injuries and increases productivity.



TOUGH

Extrusion builds durability into shelf.

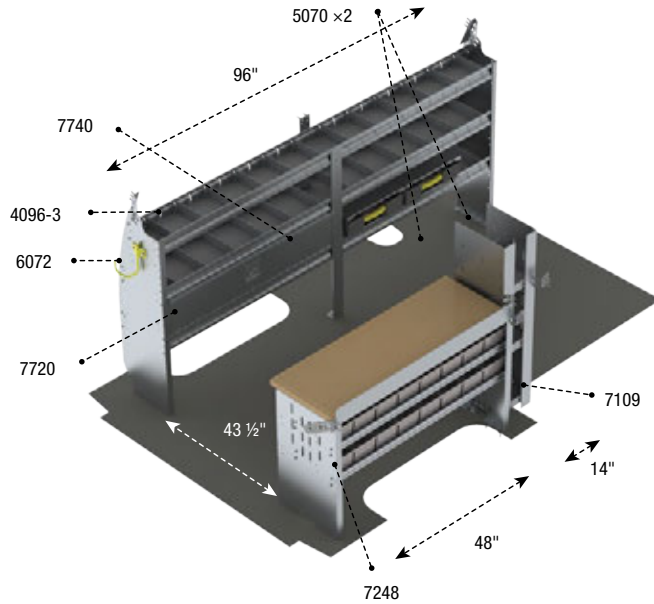

A216

Deluxe Service Package

Aluminum

135", 155"

Standard

231 lbs

4.2 hrs

No

Qty	Part #	Description
1	4096-3	Shelf unit, contoured, full-size van
2	5070	Partskeeper shelf mount
1	6072	Large hook, swivel
1	7109	Bookshelf
1	7248	Workbench
1	7720	Locking door kit
1	7740	Shelf block, universal kit

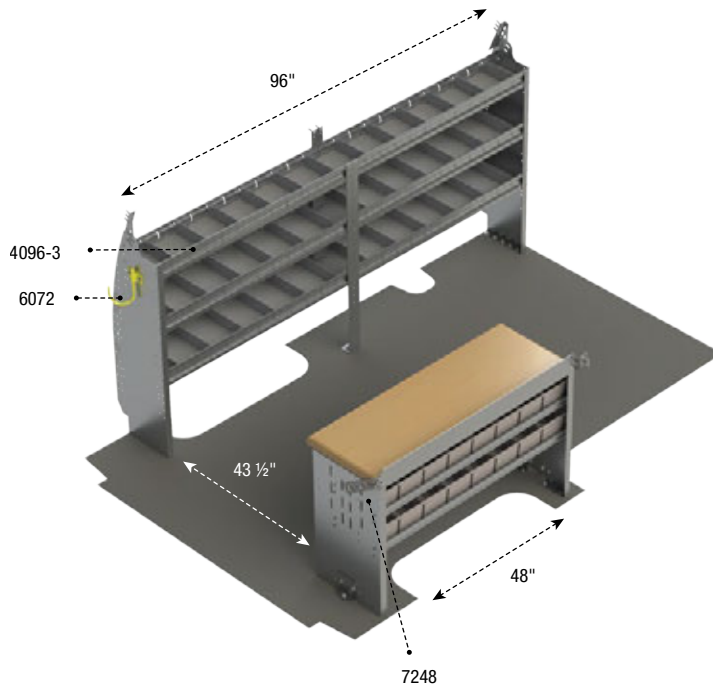

A316

Base Service Package

Aluminum

135", 155"

Standard

184 lbs

2.2 hrs

No

Qty	Part #	Description
1	4096-3	Shelf unit, contoured, full-size van
1	6072	Large hook, swivel
1	7248	Workbench

WORKSTATION PACKAGES

PACKAGES

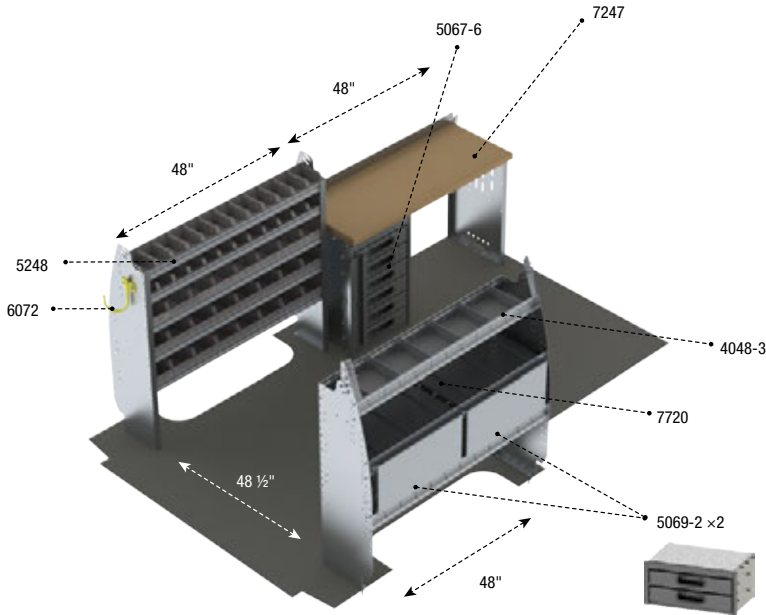

A217 Deluxe WorkStation Package

Aluminum

135", 155"

Standard

332 lbs

5 hrs

No

Qty	Part #	Description
1	4048-3	Shelf unit, contoured, full-size van
1	5067-6	Drawer cabinet
2	5069-2	Drawer cabinet
1	5248	Bin unit, contoured, full-size van
1	6072	Large hook, swivel
1	7247	Workbench
1	7720	Locking door kit

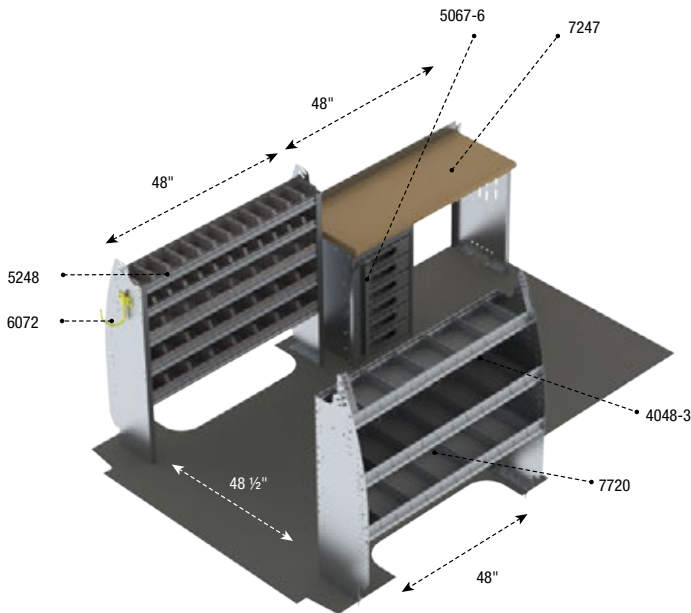

A317 Base WorkStation Package

Aluminum

135", 155"

Standard

260 lbs

4 hrs

No

Qty	Part #	Description
1	4048-3	Shelf unit, contoured, full-size van
1	5067-6	Drawer cabinet
1	5248	Bin unit, contoured, full-size van
1	6072	Large hook, swivel
1	7247	Workbench
1	7720	Locking door kit

CONTOURED BIN **SHELVING UNITS**



BENEFIT

Engineered to maximize cargo space. These unique shelf designs are quiet and will stand up to years of rugged use.

All shelvings on **P.35**



Earn more through an enhance professional business image.

A219

Delivery Package

*Preproduction model shown, do not use as an installation guide.



QUIET

The combination of the extrusion shelf tray and end-panels create durable, vibration-free shelves.



EFFICIENT

Ergonomic design reduces injuries and increases productivity.



TOUGH

Extrusion builds durability into shelf.

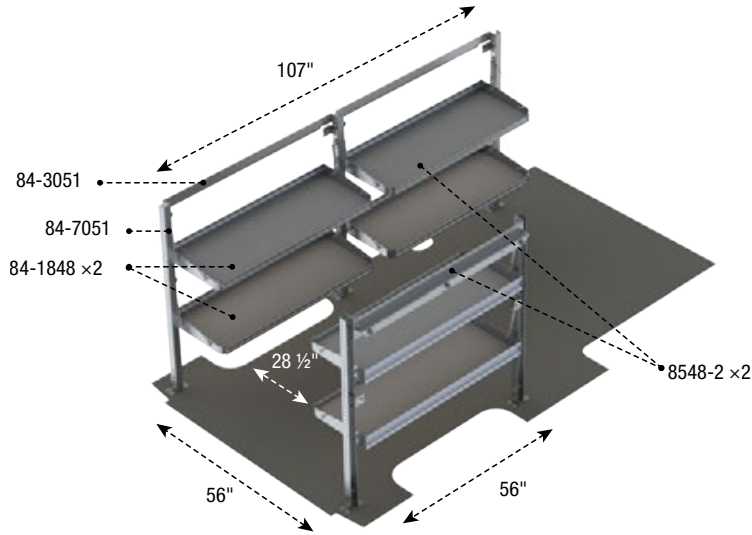

A219

Extended Length Delivery Package

Aluminum

155"	Standard	158 lbs
5.5 hrs	No	

Qty	Part #	Description
2	84-1848	Shelf tray assembly, 18" x 48", Fold-Away
1	84-3051	Mounting bar assembly, 48", Fold-Away
1	84-7051	Post assembly, 51.5" H, Fold-Away
2	8548-2	Shelf unit, Fold-Away

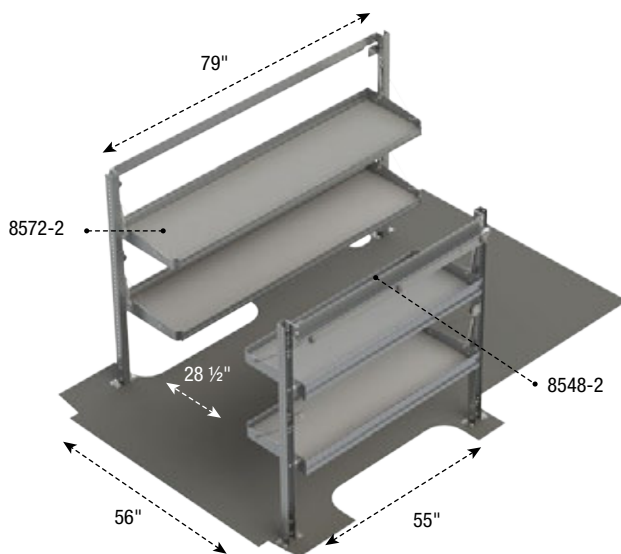

A319

Delivery Package

Aluminum

135", 155"	Standard	122 lbs
4.6 hrs	No	

Qty	Part #	Description
1	8548-2	Shelf unit, Fold-Away
1	8572-2	Shelf unit, Fold-Away

BOX TRUCK PACKAGES



PACKAGES

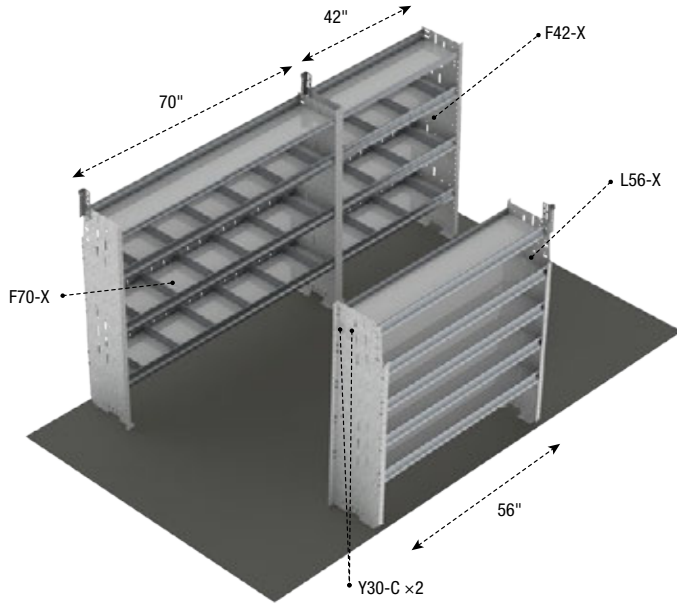

Z10-D

Contractor Package for 10' + Box

Steel

10+	Standard	275 lbs
3.4 hrs	No	

Qty	Part #	Description
1	F42-X	Shelf unit, square back
1	F70-X	Shelf unit, square back
1	L56-X	Shelf unit, square back
2	Y30-C	Small hook

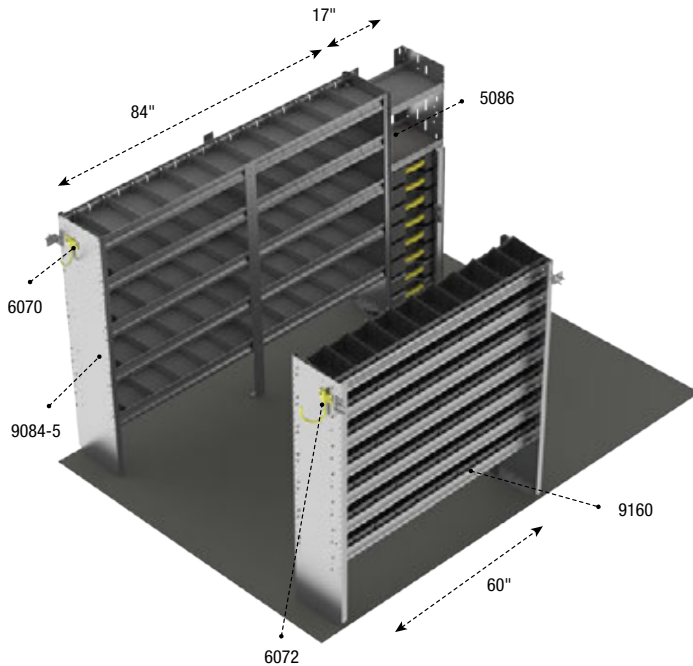

B115

Plumber Package for 10' + Box

Aluminum

10+	Standard	310 lbs
3.6 hrs	No	

Qty	Part #	Description
1	5086	Partskeeper cabinet
1	6070	Large hook, fixed
1	6072	Large hook, swivel
1	9084-5	Shelf unit, square back
1	9160	Bin unit, square back

BOX TRUCK PACKAGES

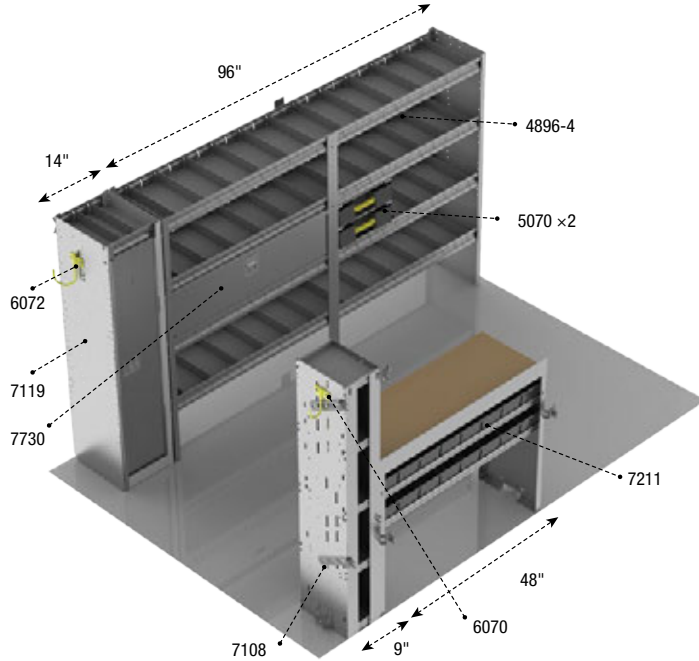

B116

Service Package for 10' + Box

Aluminum



10+



Standard



283 lbs



5.2 hrs



No

Qty	Part #	Description
1	4896-4	Shelf unit, square back
2	5070	Partskeeper shelf mount
1	6070	Large hook, fixed
1	6072	Large hook, swivel
1	7108	Bookshelf
1	7119	Locker, square back
1	7211	Workbench
1	7730	Locking door kit

PACKAGES

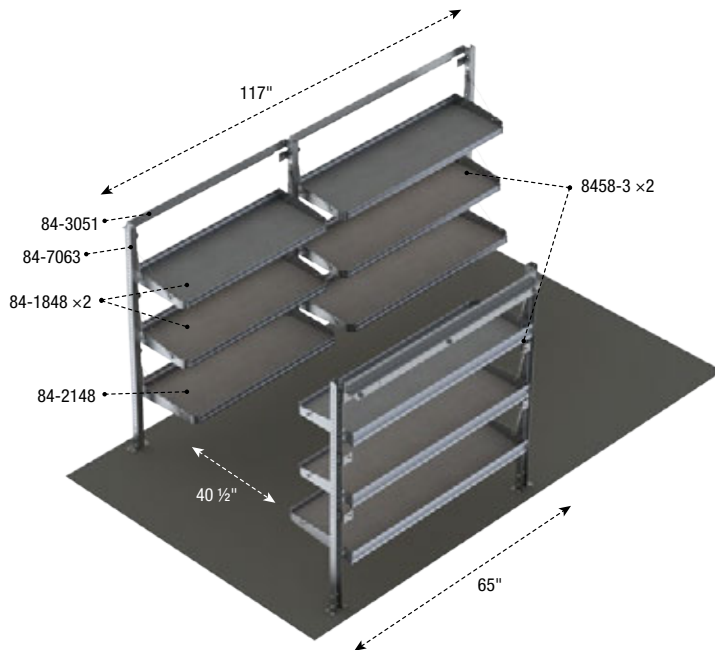

B119

Delivery Package for 10' + Box

Aluminum



10+



Standard



233 lbs



4.9 hrs



No

Qty	Part #	Description
2	84-1848	Shelf tray assembly, 18" x 48", Fold-Away
1	84-2148	Shelf tray assembly, 21" x 48", Fold-Away
1	84-3051	Mounting bar assembly, 48", Fold-Away
1	84-7063	Post assembly, 63.5" H, Fold-Away
2	8458-3	Shelf unit, Fold-Away



*Preproduction model shown, do not use as an installation guide.

Efficient layout lets you find everything quickly and easily.



PACKAGES



QUIET

The combination of the extrusion, shelf tray, and end-panels create durable, vibration-free shelves.



EFFICIENT

Ergonomic design reduces injuries and increases productivity.



TOUGH

Extrusion builds durability into shelf.

SHELVING

Industry leading strength.
The perfect fit for the toughest jobs.

BOOKSHELF P. 35

CONTOURED UNITS

CONTOURED BIN SHELVING UNIT P. 35

CONTOURED REFRIGERANT BIN UNIT P. 36

CONTOURED SHELVING UNIT P. 36

CONTOURED SHELVING UNIT W/ DIVIDERS P. 37

FOLD-AWAY SHELVING P. 39

DOORS P. 41

LOCKER P. 42

SQUARE BACK BIN SHELVING UNIT P. 40

WORKBENCHES P. 42

Ranger Design shelving is built strong and durable and often outlasts the vehicle. Designed to fit with maximum efficiency, Ranger shelving optimizes the space in a work van's cargo area.



TOUGH

Extrusion builds durability into shelf



QUIET

Shelf tray, end panel and extrusion are engineered to be vibration free



ORGANIZED

A well-planned van outfit increases productivity



Bookshelf

Aluminum

7109	14" D x 9" W x 43" H	18 lbs				0.4 hr	No



Contoured Bin Shelving Unit

Aluminum

5236	12.5" D x 36" W x 43" H	49 lbs			18 (sm), 18 (md)	1 hr	No
5248	12.5" D x 48" W x 43" H	61 lbs			24 (sm), 24 (md)	1 hr	No
5260	12.5" D x 60" W x 43" H	75 lbs			30 (sm), 30 (md)	1 hr	No



Contoured Bin Shelving Unit

Aluminum

9636	16.5" D x 36" W x 43" H	53 lbs			12 (md), 8 (lrg)	1 hr	No
9648	16.5" D x 48" W x 43" H	67 lbs			16 (md), 12 (lrg)	1 hr	Yes
9660	16.5" D x 60" W x 43" H	79 lbs			20 (md), 14 (lrg)	1 hr	No



Contoured Bin Shelving Unit

Steel







H38-A	15" D x 38" W x 46" H	63 lbs	3 Shelves (9", 12", 13")	6	6	1 hr	No
H42-A	15" D x 42" W x 46" H	68 lbs	3 Shelves (9", 12", 13")	6	7	1 hr	No
H56-A	15" D x 56" W x 46" H	81 lbs	3 Shelves (9", 12", 13")	8	9	1 hr	No
H70-A	15" D x 70" W x 46" H	95 lbs	3 Shelves (9", 12", 13")	8	11	1 hr	No



SHELVING – CONTOURED BIN SHELVING UNIT

Contoured Bin Shelving Unit









Steel

							
H87-A	15" D x 87" W x 46" H	116 lbs	3 Shelves (9", 12", 13")	12	14	1 hr	No



Contoured Refrigerant Bin Unit







Aluminum

								
5448	12.5" D x 48" W x 43" H	42 lbs		4		24 (sm)	1 hr	No
5460	12.5" D x 60" W x 43" H	50 lbs		5		30 (sm)	1 hr	No



Contoured Shelving Unit



Steel

							
L38-A	14" D x 38" W x 46" H	61 lbs	4 Shelves (9", 12", 13", 13")			1 hr	No
L42-A	14" D x 42" W x 46" H	65 lbs	4 Shelves (9", 12", 13", 13")			1 hr	No
L56-A	14" D x 56" W x 46" H	78 lbs	4 Shelves (9", 12", 13", 13")			1 hr	No
L70-A	14" D x 70" W x 46" H	91 lbs	4 Shelves (9", 12", 13", 13")			1 hr	No



Contoured Shelving Unit

Steel







							
L87-A	14" D x 87" W x 46" H	113 lbs	4 Shelves (9", 12", 13", 13")			1 hr	No



CONTOURED SHELVING UNIT WITH DIVIDERS – SHELVING

Contoured Shelving Unit with Dividers







Aluminum

							
4036-3	14" D x 36" W x 43" H	36 lbs	3 Shelves (8", 11", 12")	18	7723	0.8 hr	No
4048-3	14" D x 48" W x 43" H	44 lbs	3 Shelves (8", 11", 12")	18	7720	0.8 hr	No
4060-3	14" D x 60" W x 43" H	52 lbs	3 Shelves (8", 11", 12")	24	7722	0.8 hr	No



Contoured Shelving Unit with Dividers







Aluminum

							
4036-4	14" D x 36" W x 43" H	45 lbs	4 Shelves (8", 10", 11", 12")	24	N/A	0.8 hr	No
4048-4	14" D x 48" W x 43" H	54 lbs	4 Shelves (8", 10", 11", 12")	24	N/A	0.8 hr	No
4060-4	14" D x 60" W x 43" H	64 lbs	4 Shelves (8", 10", 11", 12")	32	N/A	0.8 hr	No



Contoured Shelving Unit with Dividers

Aluminum

							
4072-3	14" D x 72" W x 43" H	60 lbs	3 Shelves (8", 11", 12")	30	7723	1 hr	No
4084-3	14" D x 84" W x 43" H	68 lbs	3 Shelves (8", 11", 12")	30	N/A	1 hr	No
4096-3	14" D x 96" W x 43" H	78 lbs	3 Shelves (8", 11", 12")	36	7720	1 hr	Yes



RANGER DESIGN PARTSKEEPER

The Ranger Design Partskeeper helps the mobile technician to take small parts anywhere on the job site and save return trips to the van. Removable bins included.







P.50



SHELVING – CONTOURED SHELVING UNIT WITH DIVIDERS

Contoured Shelving Unit with Dividers







Aluminum

							
4072-4	14" D x 72" W x 43" H	74 lbs	4 Shelves (8", 10", 11", 12")	40	N/A	1 hr	No
4084-4	14" D x 84" W x 43" H	85 lbs	4 Shelves (8", 10", 11", 12")	40	N/A	1 hr	No
4096-4	14" D x 96" W x 43" H	97 lbs	4 Shelves (8", 10", 11", 12")	48	N/A	1 hr	No



Contoured Shelving Unit with Dividers







Aluminum

							
9536-3	16.5" D x 36" W x 43" H	44 lbs	3 Shelves (11", 14", 15")	12	7728	1 hr	No
9548-3	16.5" D x 48" W x 43" H	53 lbs	3 Shelves (11", 14", 15")	18	7725	1 hr	No
9560-3	16.5" D x 60" W x 43" H	63 lbs	3 Shelves (11", 14", 15")	24	7727	1 hr	No



Contoured Shelving Unit with Dividers





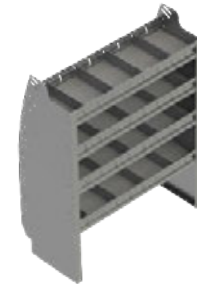

Aluminum

							
9536-4	16.5" D x 36" W x 43" H	53 lbs	4 Shelves (11", 13", 14", 15")	16	N/A	1 hr	No
9548-4	16.5" D x 48" W x 43" H	66 lbs	4 Shelves (11", 13", 14", 15")	24	7720	1 hr	No
9560-4	16.5" D x 60" W x 43" H	79 lbs	4 Shelves (11", 13", 14", 15")	32	7722	1 hr	No



Contoured Shelving Unit with Dividers

Aluminum







							
9572-3	16.5" D x 72" W x 43" H	76 lbs	3 Shelves (11", 14", 15")	24	7728	1 hr	No
9584-3	16.5" D x 84" W x 43" H	86 lbs	3 Shelves (11", 14", 15")	30	N/A	1 hr	No
9596-3	16.5" D x 96" W x 43" H	95 lbs	3 Shelves (11", 14", 15")	36	7725	1 hr	No



CONTOURED SHELVING UNIT WITH DIVIDERS – SHELVING

Contoured Shelving Unit with Dividers







Aluminum

							
9572-4	16.5" D x 72" W x 43" H	94 lbs	4 Shelves (11", 13", 14", 15")	32	N/A	1 hr	No
9584-4	16.5" D x 84" W x 43" H	108 lbs	4 Shelves (11", 13", 14", 15")	40	N/A	1 hr	No
9596-4	16.5" D x 96" W x 43" H	120 lbs	4 Shelves (11", 13", 14", 15")	48	7720 x2	1 hr	No



Contoured Shelving Unit with Dividers







Steel

							
F38-A	15" D x 38" W x 46" H	53 lbs	3 Shelves (9", 12", 13")	6	Y12-D	1 hr	No
F42-A	15" D x 42" W x 46" H	56 lbs	3 Shelves (9", 12", 13")	6	Y12-F	1 hr	Yes
F56-A	15" D x 56" W x 46" H	66 lbs	3 Shelves (9", 12", 13")	8	Y12-J	1 hr	No
F70-A	15" D x 70" W x 46" H	77 lbs	3 Shelves (9", 12", 13")	8	Y12-C	1 hr	No



Contoured Shelving Unit with Dividers







Steel

							
F87-A	15" D x 87" W x 46" H	95 lbs	3 Shelves (9", 12", 13")	12	Y12-F	1 hr	Yes



Fold-Away Shelving

Aluminum

							
8548-2	18" D x 55" W x 53.5" H	52 lbs	2 Shelves (17", 17")			1.2 hrs	Yes
8558-2	18" D x 65" W x 53.5" H	59 lbs	2 Shelves (17", 17")			1.2 hrs	Yes
8572-2	18" D x 79" W x 53.5" H	70 lbs	2 Shelves (17", 17")			1.3 hrs	Yes







*Weight capacity for fold-away shelving is 65 lbs / linear foot.



SHELVING – MOUNTING BAR

Fold-Away Shelf Tray with Gas Shocks and Hardware

Aluminum







							
84-1830	18" D x 30" H	15 lbs	17"			0.4 hr	No
84-1836	18" D x 36" H	17 lbs	17"			0.4 hr	Yes
84-1848	18" D x 48" H	18 lbs	17"			0.4 hr	No
84-1858	18" D x 58" H	21 lbs	17"			0.4 hr	No
84-1872	18" D x 72" H	26 lbs	17"			0.44 hr	Yes
84-2130	21" D x 30" H	16 lbs	20"			0.4 hr	No
84-2136	21" D x 36" H	17 lbs	20"			0.4 hr	Yes
84-2148	21" D x 48" H	20 lbs	20"			0.4 hr	Yes
84-2158	21" D x 58" H	23 lbs	20"			0.43 hr	Yes
84-2172	21" D x 72" H	28 lbs	20"			0.46 hr	Yes

La capacité de charge des étagères repliables est de 65 lb par pied linéaire.



Mounting Bar Assembly for Fold-Away Shelving





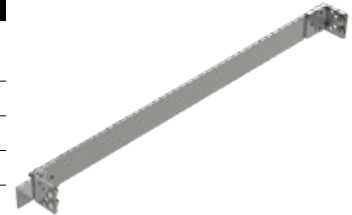

Aluminum

							
84-3033	2" D x 33" W	3 lbs				0.1 hr	No
84-3039	2" D x 39" W	3 lbs				0.1 hr	Yes
84-3051	2" D x 51" W	4 lbs				0.11 hr	Yes
84-3061	2" D x 61" W	5 lbs				0.12 hr	Yes
84-3075	2" D x 75" W	6 lbs				0.14 hr	Yes



Post Assembly for Fold-Away Shelving







Aluminum

							
84-7051	2" D x 2" W x 51.5" H	6 lb				0.2 hr	Yes



Square Back Bin Shelving Unit





Aluminum

							
7848	11" D x 48" W x 13.25" H	25 lbs			16 (md)	0.5 hr	No









Shelving Doors

Aluminum						
		Use with shelf width				
7720	44.88" W x 8.69" H	48", 96"	7 lbs	0.5 hr	No	
7722	56.88" W x 8.69" H	60"	9 lbs	0.5 hr	No	
7723	32.88" W x 8.69" H	36", 72"	5 lbs	0.5 hr	No	
7724	20.88" W x 8.69" H	24"	4 lbs	0.5 hr	No	
7725	44.88" W x 10.38" H	48", 96"	8 lbs	0.5 hr	Yes	
7727	56.88" W x 10.38" H	60"	9 lbs	0.5 hr	No	
7728	32.88" W x 10.38" H	36", 72"	6 lbs	0.5 hr	Yes	
7729	20.88" W x 10.38" H	24"	4 lbs	0.5 hr	No	
7730	44.88" W x 12.06" H	48", 96"	8 lbs	0.5 hr	Yes	
7731	38.88" W x 12.06" H	84"	8 lbs	0.5 hr	No	
7732	56.88" W x 12.06" H	60"	10 lbs	0.5 hr	No	
7733	32.88" W x 12.06" H	36", 72"	6 lbs	0.5 hr	No	
7734	20.88" W x 12.06" H	24"	5 lbs	0.5 hr	No	
7735	44.88" W x 13.75" H	48", 96"	9 lbs	0.5 hr	No	
7737	56.88" W x 13.75" H	60"	11 lbs	0.5 hr	No	
7738	32.88" W x 13.75" H	36", 72"	7 lbs	0.5 hr	No	
7739	20.88" W x 13.75" H	24"	5 lbs	0.5 hr	No	







Shelf Block

Aluminum						
		Use with shelf width				
7740	12" W x Adjustable from 11 1/4" to 6 5/16"	All	3 lbs	0.5 hr	No	







Shelving Doors

Steel						
		Use with shelf width				
Y10-C	34.88" W x 8.69" H	70"	9 lbs	0.5 hr	Yes	
Y10-D	37.88" W x 8.69" H	38"	10 lbs	0.5 hr	No	
Y10-F	41.88" W x 8.69" H	42", 87"	12 lbs	0.5 hr	Yes	
Y10-H	47.88" W x 8.69" H	48"	14 lbs	0.5 hr	No	
Y10-M	31.88" W x 8.69" H	32"	8 lbs	0.5 hr	No	
Y11-C	34.88" W x 10.38" H	70"	10 lbs	0.5 hr	Yes	
Y11-D	37.88" W x 10.38" H	38"	11 lbs	0.5 hr	Yes	
Y11-E	35.88" W x 10.38" H	36"	10.5 lbs	0.5 hr	No	
Y11-F	41.88" W x 10.38" H	42", 87"	13 lbs	0.5 hr	Yes	
Y11-M	31.88" W x 10.38" H	32"	8 lbs	0.5 hr	No	
Y12-C	34.88" W x 12.06" H	70"	10 lbs	0.5 hr	No	
Y12-D	37.88" W x 12.06" H	38"	12 lbs	0.5 hr	No	
Y12-F	41.88" W x 12.06" H	42", 87"	14 lbs	0.5 hr	No	
Y12-M	31.88" W x 12.06" H	32"	8 lbs	0.5 hr	No	



Shelving Doors

Steel						
		Use with shelf width				
Y10-J	55.88" W x 8.69" H	56"	15 lbs	0.5 hr	No	
Y11-J	55.88" W x 10.38" H	56"	16 lbs	0.5 hr	No	
Y12-J	55.88" W x 12.06" H	56"	17 lbs	0.5 hr	No	

LOCKER & WORKBENCHES – DOORS

7118

Contoured locker w/top shelf

Aluminum



16.5" D x 14" W x 43" H



30 lbs



1 hr



No

7248

Workbench w/hardwood top, 2 bin shelves

Aluminum



18" D x 48" W x 28" H



75 lbs



1 hr



Yes

7247

Workbench w/hardwood top, one end panel (Drawer cabinet not included)

Aluminum



18" D x 48" W x 28" H



47 lbs



1 hr



No

SHELVING

NEW RANGER DESIGN GRAPHITE BINS



BENEFIT

New graphite bin color provides a neutral balance that allows for more light and blends easily with existing colors.

P.53





TOUGH

Proline drawers are backed by a 10 year warranty.



QUICK

Easy to use slam latch.



SECURE

Keyed lock to guard valuables.

DRAWERS

Durable storage compartments, designed for quick and easy access.

AXESS TRAYS P. 44

CAB BOX P. 46

COMPACT DRAWERS P. 49

DRAWER CABINETS P. 48

PARTSKEEPERS P. 49

PARTSLIDERS P. 46

TOOL DRAWERS P. 50

Ranger Design manufactures a variety of tough, quiet drawer systems and storage modules. Using top quality components such as full-extension, high-capacity ball-bearing drawer slides, secure locks, and Ranger Design's unique braided stainless steel cable-pull handles. These drawers are the organizational quality that you deserve.

If you never again want to experience the frustration of drawers that jam, sag, and don't latch properly, we have the solution.



DRAWERS



5032-0

Axess Tray with 1 shelf / no drawers

Aluminum

38" D x 45" W x 30" H

—

51 lbs

0.9 hr

No



5032-1

Axess Tray with 1 shelf / 1 drawer

Aluminum

38" D x 45" W x 30" H

200 lbs

89 lbs

1 hr

Yes



5032-2

Axess Tray with 1 shelf / 2 drawers

Aluminum

38" D x 45" W x 30" H

200 lbs

127 lbs

1.1 hrs

No



5032-3

Axess Tray with 1 shelf / 3 drawers

Aluminum

38" D x 45" W x 30" H

200 lbs

165 lbs

1.2 hrs

No



5032-A

Axess Tray drawer only,
complete with slides

Aluminum

38" D x 45" W

—

38 lbs

—

No

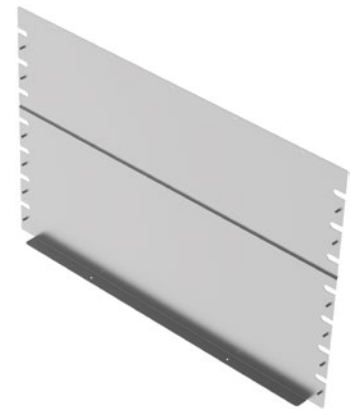

5032-F

Axess Tray full back panel for 5032 series

Aluminum

41" W x 27.25" H

—

8 lbs

0.25 hr

No



5037-0

Axess Tray with 1 shelf / no drawers

Aluminum

38" D x 45" W x 42" H

—

55 lbs

1 hr

No



5037-1

Axess Tray with 1 shelf / 1 drawer

Aluminum

38" D x 45" W x 42" H

200 lbs

93 lbs

1.1 hrs

No



5037-2

Axess Tray with 1 shelf / 2 drawers

Aluminum

38" D x 45" W x 42" H

200 lbs

131 lbs

1.2 hrs

No



5037-3

Axess Tray with 1 shelf / 3 drawers

Aluminum

38" D x 45" W x 42" H

200 lbs

169 lbs

1.3 hrs

No



5037-A

Axess Tray drawer only, c/w slides

Aluminum

38" D x 45" W

—

38 lbs

—

No

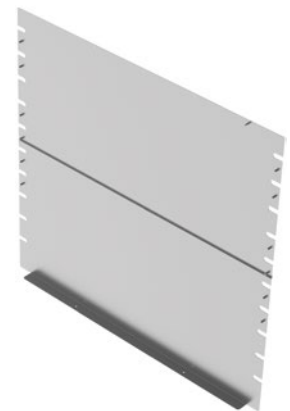

5037-F

Axess Tray full back panel for 5037 series

Aluminum

41" W x 39.25" H

—

11 lbs

0.25 hr

No

DRAWERS

DRAWERS



5045

Cab box with locking lid

Aluminum

18" D x 12" W x 16" H

—

16 lbs

0.4 hr

No



5058

Raised base for GM Van cab box

Aluminum

3.5" H

—

4 lbs

—

No



5010

Partslider drawer

Aluminum

48" D x 12" W x 6" H

150 lbs

30 lbs

0.5 hr

Yes



5011

Partslider drawer

Aluminum

36" D x 12" W x 6" H

150 lbs

26 lbs

0.5 hr

No



5014

Floor mount kit for 5010 / 5011 Partslider drawer

Aluminum

—

—

1 lb

—

No



5048

Top edge, for 5010 Partslider

Aluminum

48" D x 12" W x 4" H

—

5 lbs

0.2 hr

Yes



5049

Top edge, for 5020 Partslider

Aluminum

48" D x 14" W x 4" H

—

5 lbs

0.2 hr

Yes



5050

Top edge, for 5025 Partslider

Aluminum

48" D x 16" W x 4" H

—

5 lbs

0.2 hr

Yes



5051

Top edge, for 5011 Partslider

Aluminum

36" D x 12" W x 4" H

—

4 lbs

0.2 hr

No



5052

Top edge, for 5021 Partslider

Aluminum

36" D x 14" W x 4" H

—

4 lbs

0.2 h

No



5020 Tool drawer mounted with its complementary **5010** Partslider drawer and **5048** Top edge.

DRAWERS



5053

Top edge, for 5026 Partslider

Aluminium

36" D x 16" W x 4" H



4 lbs

0.2 h

No



5057

Top edge, for 5060 Partslider

Aluminium

18" D x 24" W x 4" H



4 lbs

0.2 h

No



5060-5

5 Drawer cabinet and 1 door

Aluminium

18" D x 24" W x 36" H

150 lbs

104 lbs

1 hr

No



5060-6

6 Drawer cabinet

Aluminium

18" D x 24" W x 36" H

150 lbs

114 lbs

1 hr

No



5060-8

8 Drawer cabinet

Aluminium

18" D x 24" W x 36" H

150 lbs

148 lbs

1 hr

No



5067-6

6 Drawer cabinet

Aluminium

18" D x 18" W x 28" H

150 lbs

97 lbs

0.5 hr

No



5068-3

3 Drawer cabinet

Aluminum

18" D x 15" W x 15" H

150 lbs

45 lbs

0.5 hr

Yes



5069-2

2 Drawer cabinet

Aluminum

14" D x 24" W x 12" H

150 lbs

34 lbs

0.5 hr

Yes



X50-B

Compact 2-Drawer Unit

Steel

12.5" D x 18.5" W x 10.5" H

—

19 lbs

0.3 hr

Yes



X50-C

Compact 3-Drawer Unit

Steel

12.5" D x 18.5" W x 10.5" H

—

20 lbs

0.3 hr

Yes



X51-F

Compact 9-Drawer Unit

Steel

12" D x 17" W x 12" H

—

26 lbs

0.3 hr

Yes



5070

Partskeeper carry case with holder, universal

Aluminum

14" D x 17" W x 5.5" H

—

7 lbs

0.3 hr

Yes

DRAWERS



5072

Partskeeper carry case with holder, floor mount

Aluminum

14" D x 17" W x 8.75" H

—

7 lbs

0.3 hr

No



5078

Partskeeper cabinet with 4 carry cases

Aluminum

14" D x 17" W x 24" H

—

23 lbs

0.3 hr

Yes

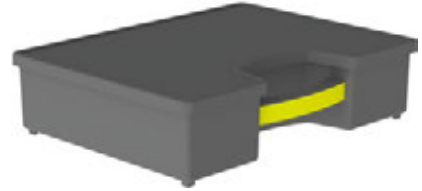

5079

Partskeeper carry case

Plastic

13" D x 16.5" W x 4" H

—

3 lbs

—

No



5082

Partskeeper cabinet with 8 carry cases

Aluminum

14" D x 17" W x 43" H

—

48 lbs

1 hr

Yes



5083

Partskeeper cabinet with 5 carry cases & 2 shelves

Aluminum

14" D x 17" W x 43" H

—

41 lbs

1 hr

Yes



5020

Tool drawer

Aluminum

48" D x 14" W x 16" H

320 lbs

46 lbs

1 hr

Yes



5021

Tool drawer

Aluminum

36" D x 14" W x 16" H

320 lbs

39 lbs

1 hr

No



5025

Jumbo tool drawer

Aluminum

48" D x 16" W x 19" H

320 lbs

61 lbs

1 hr

Yes



5026

Jumbo tool drawer

Aluminum

36" D x 16" W x 19" H

320 lbs

54 lbs

1 hr

No



5028

Raised base for 5020 tool drawer

Aluminum

6" D x 14" W x 6" H

—

8 lbs

0.5 hr

No



5029

Raised base for 5025 Jumbo tool drawer

Aluminum

6" D x 16" W x 6" H

—

8 lbs

0.5 hr

No



X02-A

Fleetline Tool Drawer

Steel

45.5" D x 13.5" W x 27.5" H

—

80 lbs

1 hr

Yes



ACCESSORIES

Choose the finishing details to tailor the upfit to your specific needs.

BINS P. 53

BOTTLE HOLDERS P. 54

HOOKS P. 57

OTHERS P. 56

PAPER HOLDERS P. 60

SEAT COVER P. 55

WINDOW GRILLS P. 61

The finishing details are just as important when you're setting up your commercial van as they are when you're on the job site. Customize your vehicle with our wide range of options to ensure that you can perform at peak efficiency.



VERSATILE

Removable storage bins ensure organization on the jobsite or on the go.



SECURE

Trade specific accessories with a place for all tools and supplies.



PRODUCTIVE

Stay productive with the most used items well within reach.

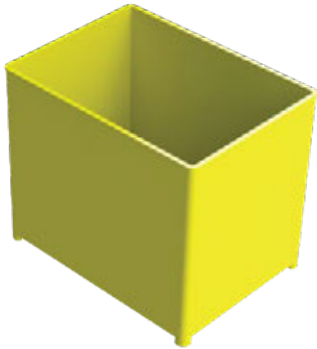

6205

Bin cup

Plastic

4.5" D x 3.25" W x 3.75" H

0.12 lb

-

No



6211

Small Bin, Graphite

Plastic

6.5" D x 4" W x 3" H

0.24 lb

-

Yes

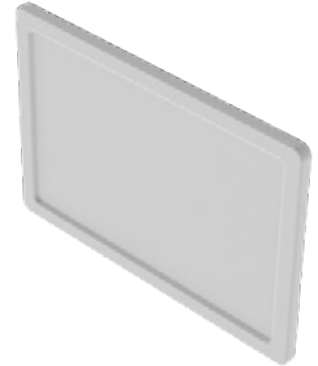

6212

Divider for 6211 small bin

Aluminum

-

-

-

No



6221

Medium Bin, Graphite

Plastic

10" D x 6" W x 4.5" H

0.56 lb

-

Yes



6222

Divider for 6221 medium bin

Aluminum

-

-

-

No



6231

Large Bin, Graphite

Plastic

14" D x 8" W x 5.5" H

1.33 lbs

-

Yes

ACCESSORIES

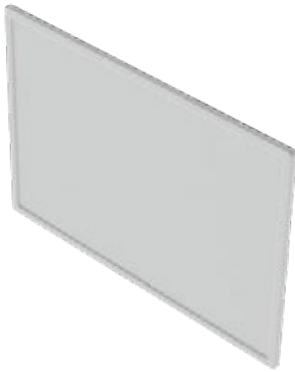

6232

Divider for 6231 large bin

Aluminum

—

—

—

No



6006

3 Tier refrigerant rack for small bottles

Aluminum

14" D x 10.5" W x 43" H

24 lbs

0.6 hr

No



6007

4 Tier refrigerant rack for small bottles

Aluminum

14" D x 10.5" W x 43" H

22 lbs

0.6 hr

Yes



6007 4 Tier refrigerant rack for small bottles

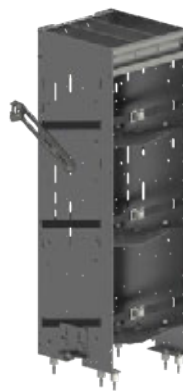

6008

3 Tier refrigerant rack for large bottles

Aluminum

14" D x 13" W x 43" H

25 lbs

0.6 hr

No



6010

Two level adjustable bottle holder

Aluminum

10.25" D x 9.5" W x 36" H

5 lbs

0.4 hr

No

INTRODUCING THE NEW RANGER DESIGN

SEAT COVERS



OUR KEY ADVANTAGES INCLUDE:

- › Durable material and easy maintenance
- › Urethane coating to make the fabric water and stain resistant
- › Machine wash and dryer safe
- › Easy installation of 30 minutes or less for a set
- › No interference with factory seat functions (heating, cooling or air bag)
- › Minimal seams
- › Tight custom fit for each vehicle, guaranteed to stay in place
- › Puncture resistant to prevent seat damage
- › Durable Cordura® fabric with a 1 year warranty

6252

SPECIFICATIONS

for 1 set of bucket seat covers

	4 lbs
	0.5 hr
	Yes

THE PERFECT FIT
FOR YOUR TOUGHEST JOBS

RANGERTM
DESIGN

Our Promise: To Help You Work More Effectively by Providing Organized Storage Solutions.

ACCESSORIES



6020

Horizontal refrigerant bottle holder
Can accommodate 4 bottles

Aluminum

12.5" D x 48" W x 13" H

17 lbs

0.5 hr

No



6030

Bottle rack with straps
(can accommodate 4 bottles)

Aluminum

48" W

4 lbs

0.5 hr

No



6035

Bottle rack with straps
(can accommodate 5 bottles)

Aluminum

60" W

5 lbs

0.5 hr

No



6040

Locking cabinet

Aluminum

8.5" D x 12" W x 24" H

16 lbs

0.6 hr

No



6041

Locking cabinet

Aluminum

15" D x 15.5" W x 33" H

26 lbs

0.7 hr

No

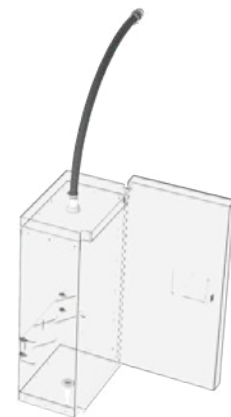

6049

Ventilation kit for cabinet

Aluminum

-

-

-

No



6088

Large aluminum bottle holder, comes with two black nylon straps

Aluminum

8" W x 24" H

2 lbs

0.2 hr

Yes



6086

Small aluminum bottle holder, comes with a black nylon strap

Aluminum

6" W x 12" H

1 lb

0.2 hr

Yes



6070

6" Hook, 3" opening, painted

Steel

3" D

0.4 lb

0.2 hr

Yes



6072

8" Swivel Hook, 4" opening, painted

Steel

4" D

0.6 lb

0.2 hr

Yes



6073

Large aluminum movable hook, 6.5" opening, painted

Aluminum

6.5" D x 2.75" W x 4" H

1 lb

0.01 hr

Yes



Y30-C

Coat Hook, 1" opening, chrome plated

Steel

1" D

0.1 lb

0.2 hr

Yes

ACCESSORIES



1130

Elevated strobe mount

Aluminum

8" W

1 lb

0.1 hr

No

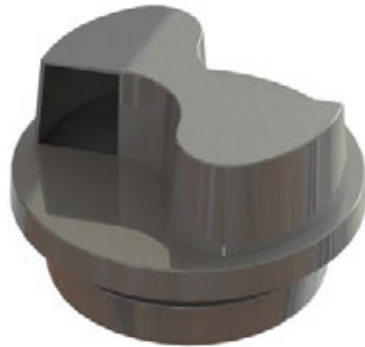

6050

Flettner vent, rotary design

Plastic

8.9" D

1.5 lbs

1 hr

No

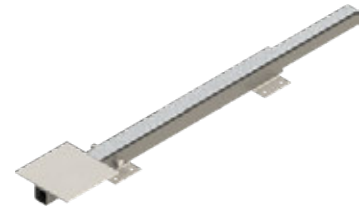

6052

Vise Holder with an 8"x8" mounting plate

Steel

-

37 lbs

0.5 hr

No

ACCESSORIES



6054

Hitch Step, comes with hitch pin to fit a 2"x 2" hitch

Aluminum

6" D x 12" W

4 lbs

-

No



6057

Can Holder

Aluminum

3" D x 8.5" W x 3" H

1 lb

0.2 hr

No



6075

Transport tube door, for 6" diameter tube with stainless steel hardware

Aluminum

6" D

2 lbs

0.2 hr

No



6078

Cradle & strap kit for 6" dia. transport tube (one cradle and one strap)

Aluminum

6" D

1 lb

0.1 hr

No

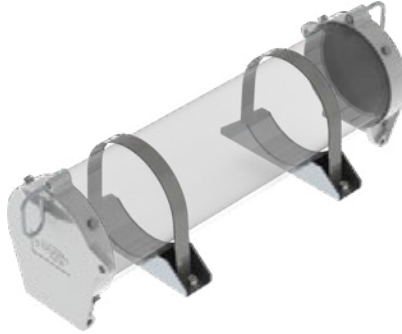

6079

Transport tube door kit complete (tube non included)

Aluminum

6" D

6 lbs

0.8 hr

No



6082

Triangle kit with aluminum holder

Other

—

14 lbs

0.2 hr

No



6090

Back up alarm, die cast housing, fully encapsulated circuitry

Other

—

1 lb

1 hr

No



6091

Surface mount tie down ring, zinc plated

Steel

4" D

0.4 lb

0.2 hr

No



6092

Dome Light, chrome finish housing

Other

8.5" D

1 lb

1 hr

No

ACCESSORIES



6093

Grab handle

Plastic

9.5" D

0.1 lb

0.5 hr

No



7124

Reel Holder with two 5/8" diameter rods

Aluminum

7.25" D x 15" W x 24" H

9 lbs

0.5 hr

No



6061

Paper Holder, extra deep, 2 slots

Aluminum

3.75" D x 12.75" W x 12" H

2 lbs

0.2 hr

No



6063

Paper Holder, extra deep, 5 slots

Aluminum

3.75" D x 12.75" W x 24" H

5 lbs

0.2 hr

Yes



6066

2 Pocket Holder, comes with 8 plastic bins

Aluminum

4.5" D x 20" W x 21.75" H

7.5 lbs

0.2 hr

No



6067

Paper Holder, regular depth, 2 slots

Aluminum

2.25" D x 12.75" W x 12" H

2 lbs

0.2 hr

No



6068

Hard Hat Holder, painted wire

Steel

–

0.5 lb

0.2 hr

No



6069

Paper Holder, regular depth, 5 slots

Aluminum

2.25" D x 12.75" W x 24" H

5 lbs

0.2 hr

No

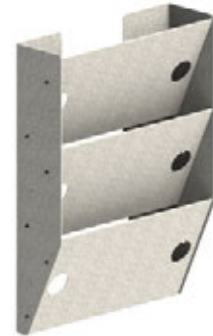

Y31-A

Paper Holder, extra deep, 3 slots

Steel

3.75" D x 12.75" W x 16" H

9 lbs

0.2 hr

Yes

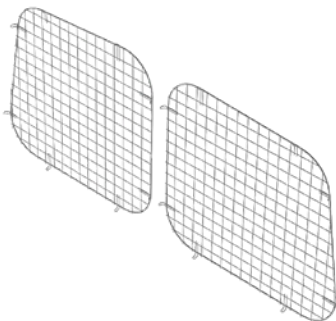

6106

Set of 2 rear window grills

Steel

Standard Roof

8 lbs

0.2 hr

No

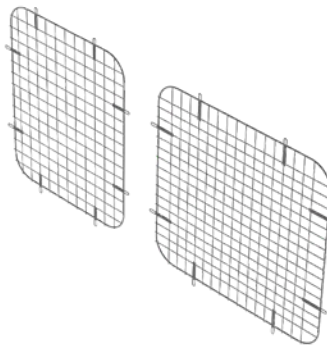

6111

Set of 2 side window grills

Steel

Standard Roof

8 lbs

0.2 hr

No

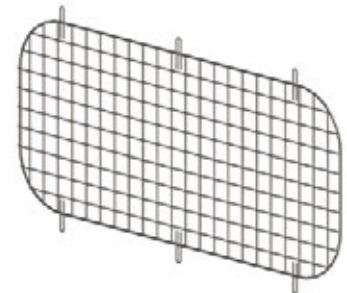

3044

Grill for partition window for 3020

Steel

–

2 lbs

–

No

LADDER RACKS

Ergonomic Ladder Racks make loading and unloading easier.

Ranger ladder racks make loading and unloading ladders an easy operation. Ranger Design offers drop-down ladder racks for high roof vans, extra tough racks capable of carrying 28' ladders on compact vans, interior ladder carriers and many other options for different applications.

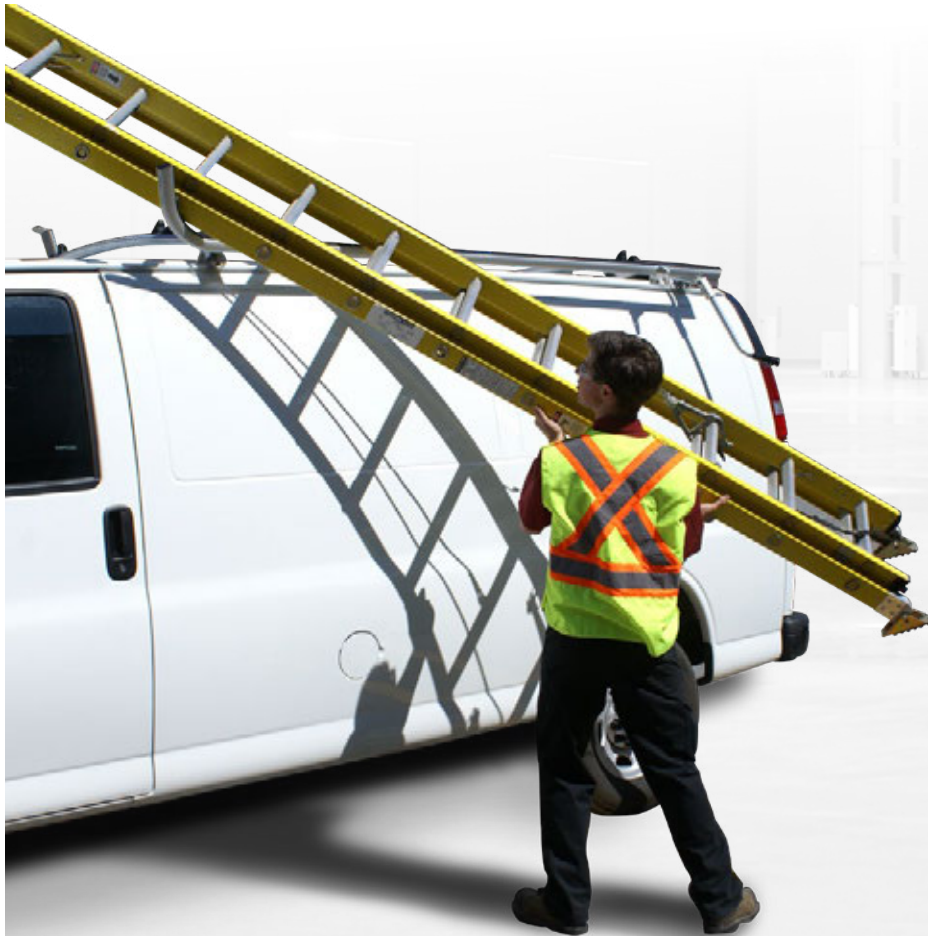

TOUGH

Military grade aluminum extrusion, high density plastic and stainless steel components ensure no corrosion over the lifetime of the rack.



QUIET

Aerodynamic design with minimal wind noise.



SAFE

No metal contact to ladder, leading to longer life of ladders with less chance of fiberglass splinters.



Access Pro, Inside Ladder Carrier

Aluminum

1050-FS	Universal	—	96"	9 lbs	1 hr	



Ladder rack accessory

Aluminum

1127	Universal	—	23"	18 lbs	0.5 hr	



Cargo rack

Aluminum

1505-GS	Universal	—	68"	480 lbs	23 lbs	0.8 hr
1505-GS3	Universal	—	68"	720 lbs	35 lbs	1.2 hr



Standard ladder rack

Aluminum

1510-FS	Universal	—	68"	400 lbs	21 lbs	0.9 hr



Single clamp ladder rack

Aluminum

1520-FS	Universal	—	68"	400 lbs	28 lbs	1.2 hrs



Combination ladder rack

Aluminum

1525-FS	Universal	—	68"	400 lbs	49 lbs	1.7 hrs



Double clamp ladder rack

Aluminum

1530-FS	Universal	—	68"	400 lbs	50 lbs	1.7 hrs

Over 350 Distributors Across the Continent

Regular Order

Quickship Order

Buy

Contact one of our 350 distributors
rangerdesign.com/find-dealer.

Ranger Quickship service is available
through your local distributor.

**Lead
Time**

Orders ship from our factory within
5 business days.

Orders placed with Ranger before 1PM EST will
ship from our factory in the next business day.



Throughout the catalog products and packages with this symbol
can be ordered through our Quickship service.

Turn-Key Fleet Services



Ship Through or Local Installation Across North America for all Types of Cargo Vans

We are pleased to offer efficient, personalized service and to answer all questions regarding:

1. Analysis

- › Cargo Needs Analysis
- › Custom 3D CAD Layouts
- › Hands-on Equipment Demo

2. Testing

- › Test Fitting
- › Pilot Build and Review
- › Optimize Package Based on Technician Feedback

3. Delivery

- › Delivery, Production and Installation Planning and Scheduling
- › Vehicle Status Tracking

4. Service

- › Dedicated Fleet Account Management Team
- › 300 Ranger Distributor Service Support Network
- › Live Customer Service

INDEX

1050-FS	63	5049	47	6078	59	84-1858	40
1127	63	5050	47	6079	59	84-1872	40
1130	58	5051	47	6082	59	84-2130	40
1505-FS	63	5052	47	6086	57	84-2136	40
1505-GS	63	5053	48	6088	57	84-2148	40
1505-GS3	63	5057	48	6090	59	84-2158	40
1510-FS	63	5058	46	6091	59	84-2172	40
1520-FS	63	5060-5	48	6092	59	84-3033	40
1525-FS	63	5060-6	48	6093	60	84-3039	40
1530-FS	63	5060-8	48	6106	61	84-3051	40
3010-GS	13	5067-6	48	6111	61	84-3061	40
3020-GS	13	5068-3	49	6205	53	84-3075	40
3044	61	5069-2	49	6211	53	84-7051	40
4036-3	37	5070	49	6212	53	8548-2	39
4036-4	37	5072	50	6221	53	8558-2	39
4048-3	37	5078	50	6222	53	8572-2	39
4048-4	37	5079	50	6231	53	9536-3	38
4060-3	37	5082	50	6232	54	9536-4	38
4060-4	37	5083	50	6252	55	9548-3	38
4072-3	37	5236	35	6540-GSR	11	9548-4	38
4072-4	38	5248	35	6540-GSX	11	9560-3	38
4084-3	37	5260	35	7109	35	9560-4	38
4084-4	38	5448	36	7118	42	9572-3	38
4096-3	37	5460	36	7124	60	9572-4	39
4096-4	38	6006	54	7247	42	9584-3	38
5010	46	6007	54	7248	42	9584-4	39
5011	46	6008	54	7720	41	9596-3	38
5014	46	6010	54	7722	41	9596-4	39
5020	50	6020	56	7723	41	9636	35
5021	51	6030	56	7724	41	9648	35
5025	51	6035	56	7725	41	9660	35
5026	51	6040	56	7727	41	A211	19
5028	51	6041	56	7728	41	A212	21
5029	51	6049	56	7729	41	A215	23
5032-0	44	6050	58	7730	41	A216	25
5032-1	44	6052	58	7731	41	A217	26
5032-2	44	6054	58	7732	41	A219	29
5032-3	44	6057	58	7733	41	A311	19
5032-A	44	6061	60	7734	41	A312	21
5032-F	44	6063	60	7735	41	A315	23
5037-0	45	6066	60	7737	41	A316	25
5037-1	45	6067	60	7738	41	A317	26
5037-2	45	6068	61	7739	41	A319	29
5037-3	45	6069	61	7740	41	B115	30
5037-A	45	6070	57	7848	40	B116	31
5037-F	45	6072	57	84-1830	40	B119	31
5045	46	6073	57	84-1836	40	C10-H	13
5048	46	6075	58	84-1848	40	C12-H	13

C20-GS	13	H87-A	36	Y10-F	41	Y12-F	41
C24-GS	13	L38-A	36	Y10-H	41	Y12-J	41
C30-GS	13	L42-A	36	Y10-J	41	Y12-M	41
F38-A	39	L56-A	36	Y10-M	41	Y30-C	57
F42-A	39	L70-A	36	Y11-C	41	Y31-A	61
F56-A	39	L87-A	36	Y11-D	41	Z05-H	16
F70-A	39	X02-A	51	Y11-E	41	Z10-D	30
F87-A	39	X50-B	49	Y11-F	41	Z10-H	16
H38-A	35	X50-C	49	Y11-J	41	Z30-H	17
H42-A	35	X51-F	49	Y11-M	41		
H56-A	35	Y10-C	41	Y12-C	41		
H70-A	35	Y10-D	41	Y12-D	41		



NEED HELP WITH YOUR ORDER

Contact us at cs@rangerdesign.com
or call **1-800-565-5321**

Ask us for our other Chevrolet product related catalogs.

Maximize Cargo Capacity & Vehicle Performance With Contractor Grade, Organized Storage Systems

When you want the perfect upfit solution for your work vehicle, turn to Ranger Design. Tested for toughness, Ranger's shelving and upfits will take whatever abuse you can dish out. Their unsurpassed craftsmanship, combined with ideal fit and finish, provide a quiet ride with no rattles.



CUSTOMER SERVICE

cs@rangerdesign.com

1-800-565-5321

rangerdesign.com



THE PERFECT FIT
FOR YOUR TOUGHEST JOBS

